

ANTAIX

THE ORIGINAL
SINCE 1979

www.antaix.com



stay

CATÁLOGO DE MOBILIARIO JUVENIL

ANTAIX

stay



ANTAIX

stay

ANTAIX

Pronto entendemos que el comienzo de una historia, de una vida, sucede aquí. Un universo propio donde la cartografía de los sueños se prolonga y todo es posible. La habitación es un lugar mágico, que nos acompaña hacia el interior de nosotros mismos.

We soon understand that the beginning of a story, of a life, happens here. A universe of our own where the cartography of dreams is prolonged and everything is possible. The room is a magical place, which accompanies us towards the interior of ourselves.



ANTAIX

THE ORIGINAL
SINCE 1979

01

Combinación de dos zonas en un mismo espacio. La zona de descanso se crea a partir del *Arcón-Mesita*, que permite gran almacenamiento en su interior al mismo tiempo que hace la función de mesita de noche. En la zona de estudio destaca el escritorio *Join*.

Combining two areas in one space. A rest area situated around a chest table which provides lots of internal storage and can, at the same time, be used as a nightstand. Plus a study space, featuring the *Join* desk.

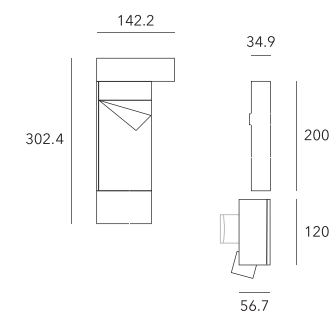

Medidas / Measures

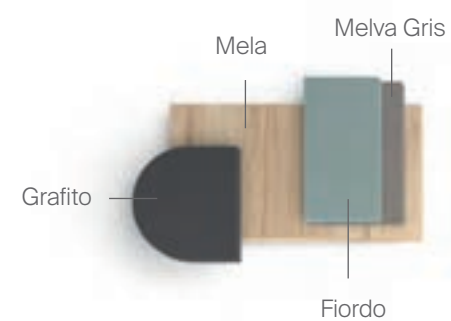

Acabados / Finishes

02

Diseño práctico compuesto de un aro elevable con hueco y contenedores más zona de estudio. El sistema *Compleat* permite crear un gran y atractivo armario.

This practical design includes the Chest bed with overhead storage and study area. The *Compleat* system allows you to create a large and attractive wardrobe.

Medidas / Measures

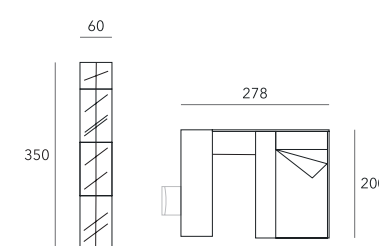

Acabados / Finishes

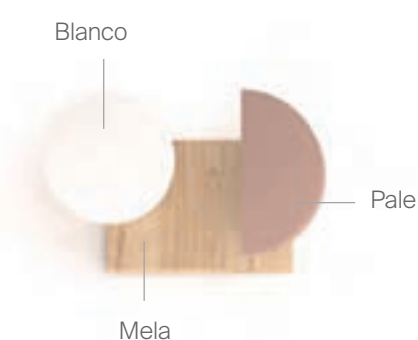





03

Propuesta juvenil muy atractiva formada por dos camas paralelas a una zona de trabajo amplia y cómoda en la que destaca el escritorio con la pata *Alpes*, que ayuda a crear un espacio único.

This beautiful kids' bedroom includes two beds and a spacious and comfortable area for study. Featuring a charming desk with *Alpes* legs for a unique space.

Medidas / Measures

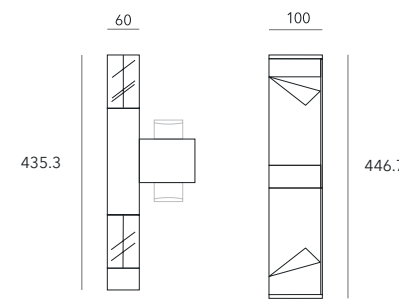

Acabados / Finishes

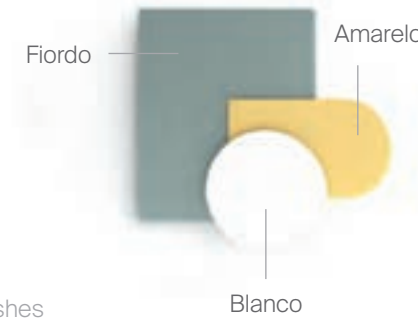

04

Dormitorio compuesto por módulos *Compleat* con el exclusivo uñero metal, zona estudio y armario de puertas correderas.

Stylish bedroom created using *Compleat* units with exclusive aluminium edge handles, study area and wardrobe with sliding doors.

Medidas / Measures

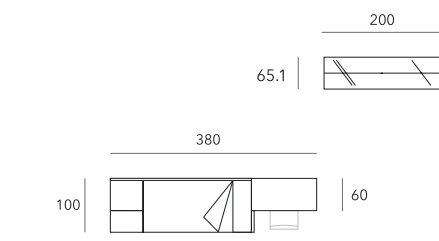

Acabados / Finishes

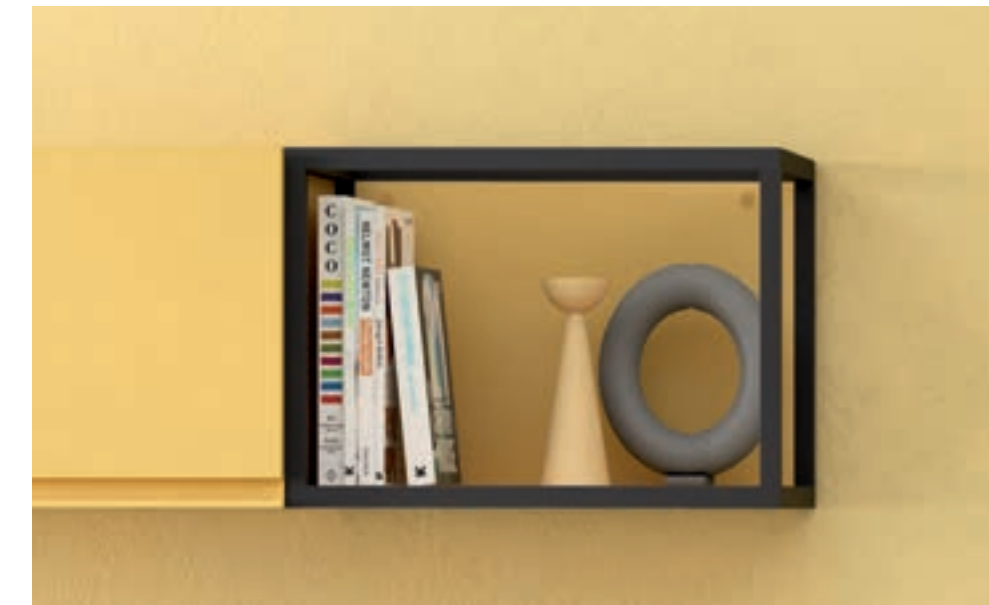
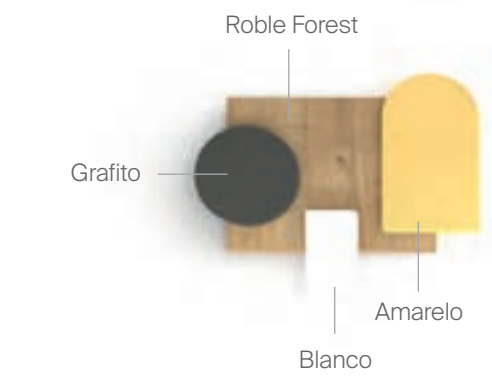

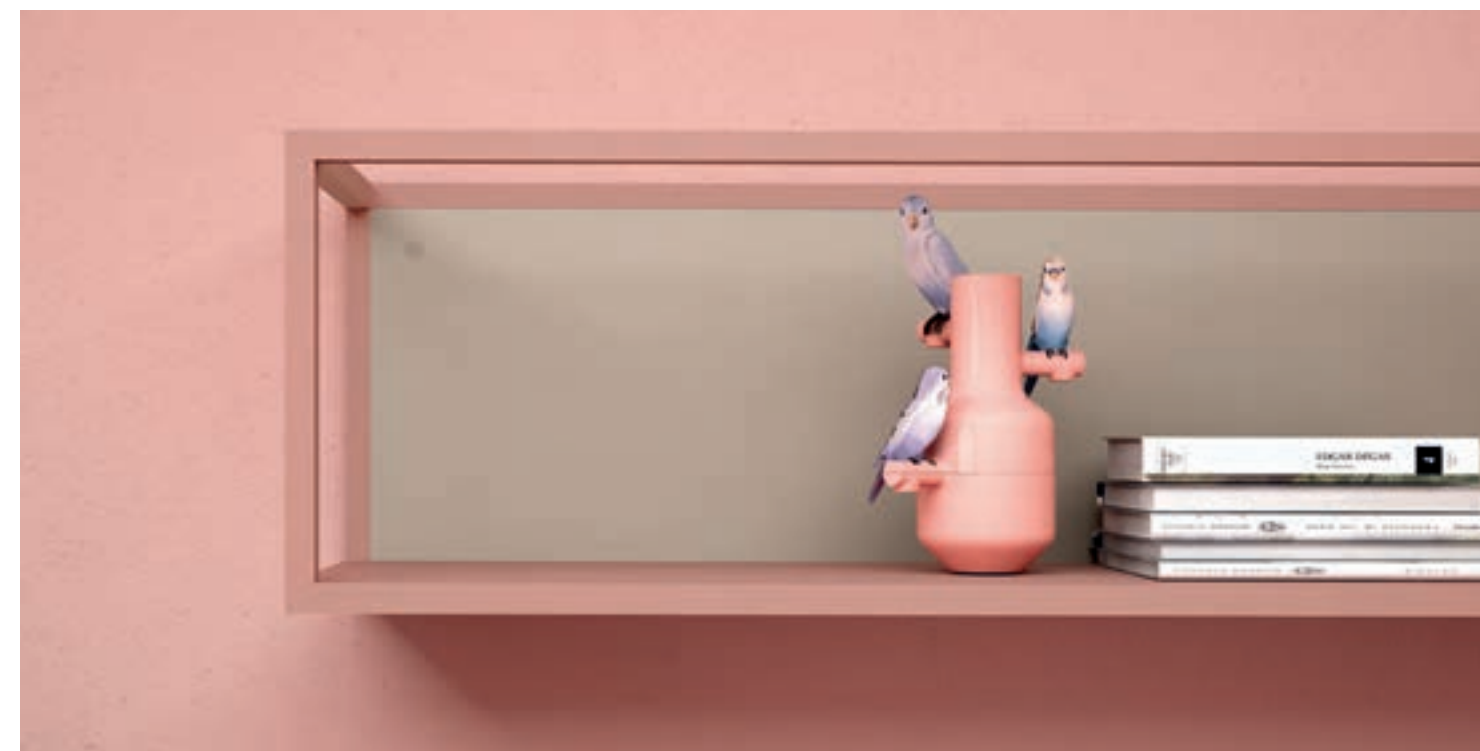

05

Composición juvenil que destaca por su gran capacidad de almacenaje en sus múltiples cajones. Se complementa con un original escritorio *Square*.

Kids' bedroom with lots of storage to be found in its many drawers, complemented by a unique *Square*.

Medidas / Measures

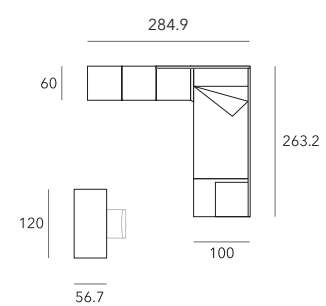

Acabados / Finishes

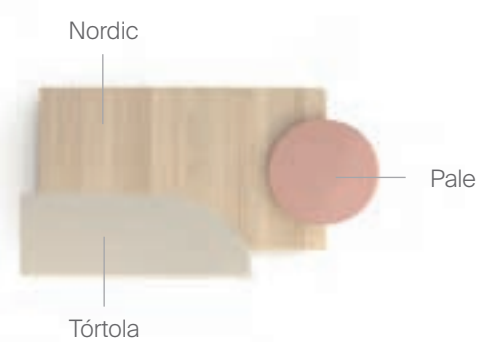





06

Ambiente fresco y juvenil compuesto por módulos *Completo*. El nido se caracteriza por su cajón diáfano que puede servir como contenedor o como cama adicional, simplemente añadiendo un colchón. La zona de estudio se ha creado con estanterías *Troya*.

Fresh and youthful space made with *Completo* units. The bed features a large drawer that can be used either for storage or, simply by adding a mattress, as an additional bed. The study area has been created using *Troya* shelves.

Medidas / Measures

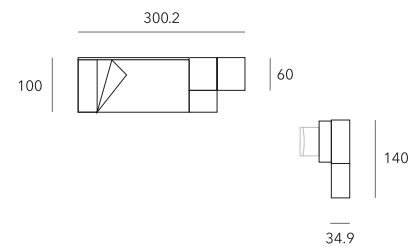

Acabados / Finishes

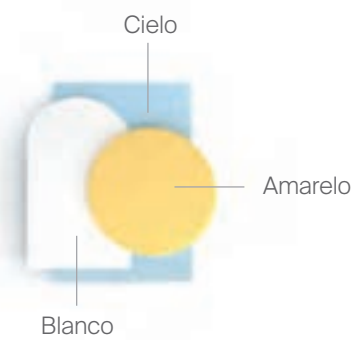

Estanterías Troya que crean una práctica zona de estudio.

DETALLE COMPOSICIÓN N°06





07

Propuesta muy completa formada por cajones bajos fácilmente accesibles. El panelado aporta al conjunto un toque de elegancia y calidez resguardando el aro elevable con hueco y contenedores. El escritorio con las patas Alpes combina perfectamente con los uneros madera.

Very complete proposal made up of easily accessible low drawers. The paneling adds a touch of elegance and warmth to the whole, protecting the canapé chest bed with hollow and containers. The desk with the Alpes legs combines perfectly with the wooden nails.





Medidas / Measures

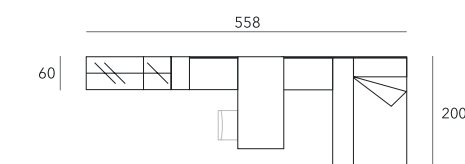

Acabados / Acabados

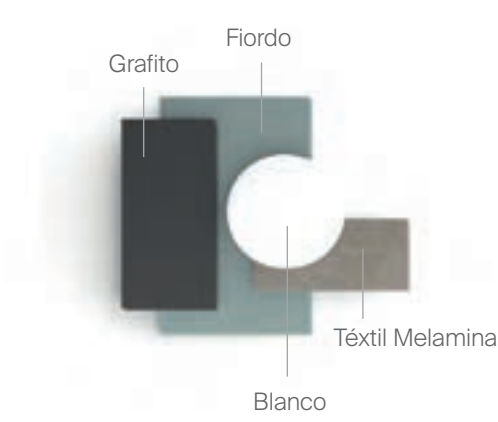



08

Diseño juvenil formado por módulos *Compleat* y un armario de gran capacidad. El escritorio ayuda a completar el conjunto, que es adaptable a espacios de pequeñas dimensiones.

Bedroom that optimizes the space to the maximum thanks to the corner chest, which is used as a storage module for its large interior capacity and as part of one of the beds. The *Compleat* cabinet with sliding doors provides new solutions for small spaces.

Medidas / Measures

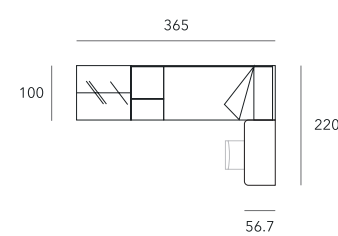

Acabados / Finishes

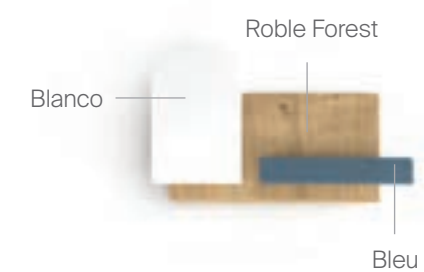

Habitación doble con posibilidad de convertirse en triple según las necesidades. La cama arcón permite aprovechar el espacio de la habitación al máximo.

Double room with the possibility of becoming triple according to the needs. The chest bed allows to take advantage of the space of the room to the maximum possible.

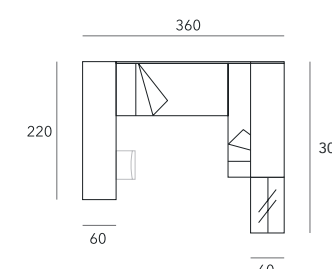

Medidas / Measures

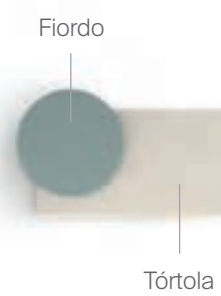

Acabados / Finishes





10

La versatilidad del sistema modular *Completo* permite crear armarios singulares y prácticos al mismo tiempo. La nueva pata de metal aporta un aire muy actual al conjunto.

The versatility of the *Completo* modular system makes it possible to create unique and practical cabinets at the same time. The new metal leg gives the whole unit a very modern look.

Medidas / Measures

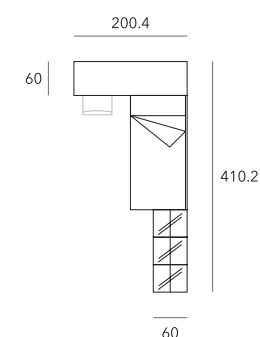

Acabados / Finishes

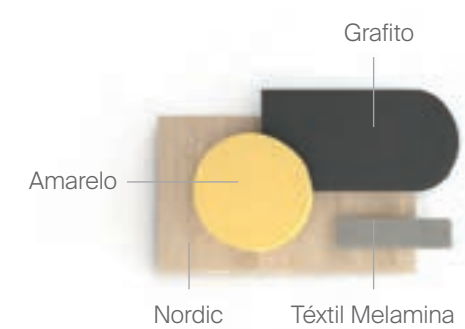



11

Ambiente para dos con elementos *Compleat* distribuidos simétricamente para que cada uno tenga su propio espacio.

Environment for two with *Compleat* elements symmetrically distributed so that each has its own space.

Medidas / Measures

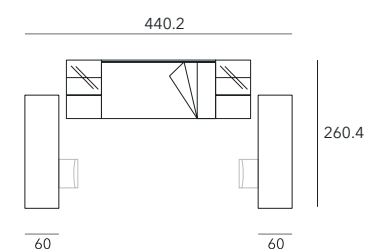

Acabados / Finishes

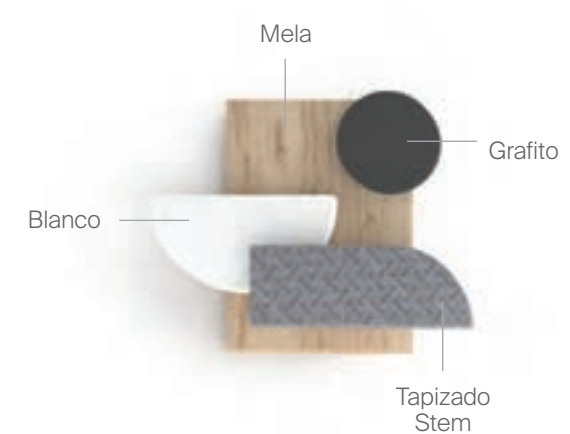



12

Dormitorio que optimiza al máximo el espacio gracias al arcón rinconero, que se utiliza como módulo de almacenaje por su gran capacidad interior y como parte de una de las camas. El armario *Completo* con puertas correderas aporta nuevas soluciones para pequeños espacios.

This bedroom maximizes space using a large capacity, corner chest, which can also be used as a part of one of the beds. The *Completo* wardrobe with sliding doors provides a smart solution for small spaces.

Medidas / Measures

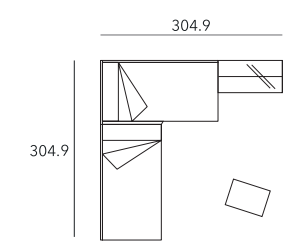

Acabados / Finishes

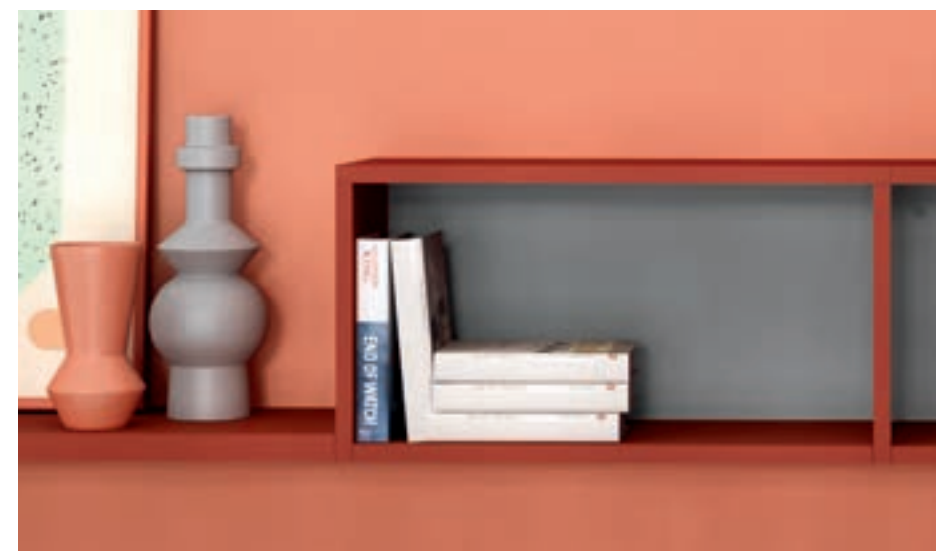
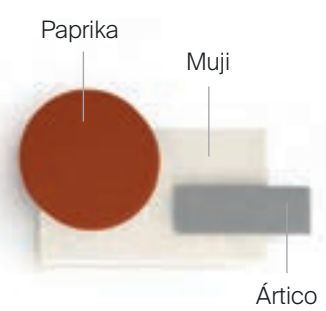



13

Habitación juvenil doble con el *Arcón-Escritorio* mesa extraíble, ideal para disponer de un espacio de trabajo y de un espacio de juego al mismo tiempo, simplemente arrastrando el sobre. El armario con altura fuelle permite ajustarse a techos con altura de hasta 269.4 cm.

Double kids' room with sliding chest table, ideal for having a work and play area simply by sliding the desk across. The wardrobe's height can be adjusted up to 269.4cm.

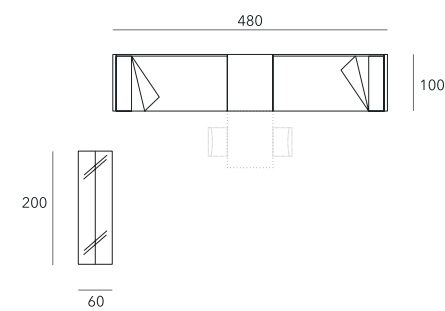

14

Combinación de sistema *Completo* ideal para espacios alargados. Los laterales de 5 cm de grosor dan un aire robusto al conjunto, mientras que el lateral *Mesita-Arcón Completo* aporta practicidad al conjunto.

This *Completo* system combination is ideal for larger spaces. The 5cm thick sides give sturdiness, while the chest *Completo* brings practicality.

Medidas / Measures

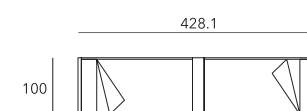

Acabados / Finishes

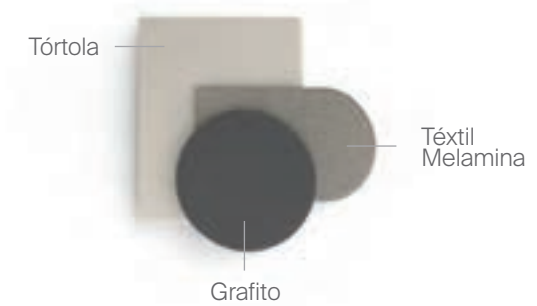

Habitación muy completa con cajones a doble altura y armario *Completo* con puertas correderas. Es una propuesta ideal para espacios reducidos que requieren de gran capacidad de almacenaje.
 This complete set with deep drawers and *Completo* wardrobe with sliding doors is a great solution for small spaces that require a lot of storage space.

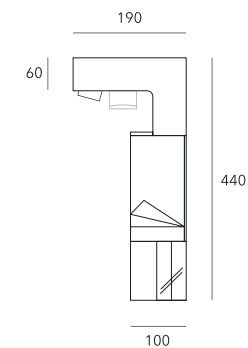

Medidas / Measures



Acabados / Finishes

Propuesta lineal que incorpora nuevos elementos abiertos como el lateral *Mesita-Arcón Complet* y la estantería a suelo *Mic* baja. El sobre estudio y el soporte, ambos de 5 cm de grosor, aportan elegancia al conjunto.

Stylish bedroom with new and original storage solutions such as the headboard with chest *Complet* and the *Mic* open shelving. The 5 cm thick desk and leg provides sturdiness to the set.

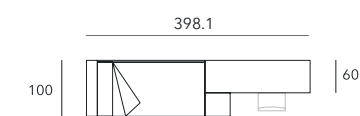

Medidas / Measures



Acabados / Finishes



17

Dormitorio juvenil fresco y actual pensado para disponer de espacio central para el juego. El escritorio *Lua* junto a las galerías colgadas crean una interesante zona de estudio, mientras que la zona de descanso resulta original y práctica gracias a la estantería frontal para cama.

This spacious and contemporary kids' bedroom combines the *Lua* floating desk along with hanging shelves to create a beautiful study area. While the rest area is unique and practical thanks to a bench at the foot of the bed with open shelving.

Medidas / Measures

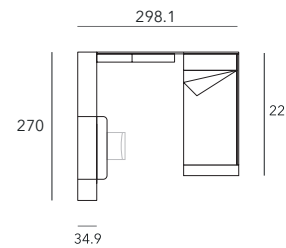

Acabados / Finishes

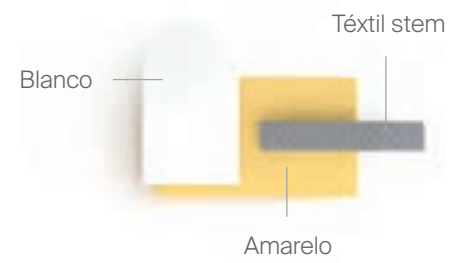

Dos ambientes en un mismo espacio. La zona de dormitorio se compone de una práctica cama elevable *UP* de gran capacidad interior y unos cajones colgados. La zona de estudio la forman una amplia mesa junto a unas estanterías a suelo *Mic* bajas.

One room that fulfills two purposes. A bedroom area composed of a practical *UP* lift storage bed with large interior capacity and hanging drawers and a study area combining a large table with *Mic* open shelving.

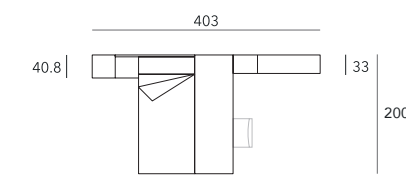

Medidas / Measures

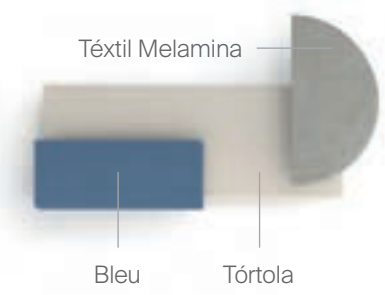

Acabados / Finishes





19

Propuesta juvenil con colores frescos. El sobre bandeja de la cómoda hace de la misma una pieza singular y exclusiva que se complementa con unas patas metálicas Lys. El Arcón-Escritorio extraíble es ideal para disponer de zona de estudio ocasional.

Kids' bedroom in fresh colors. The chest of drawers with top tray makes it a unique and exclusive piece, finished off with metal legs Lys. The sliding desk with storage is ideal for an occasional study area.

Medidas / Measures

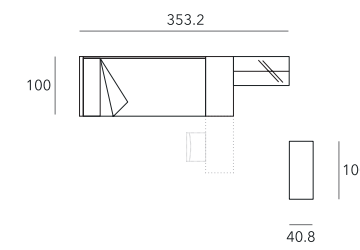

Acabados / Finishes

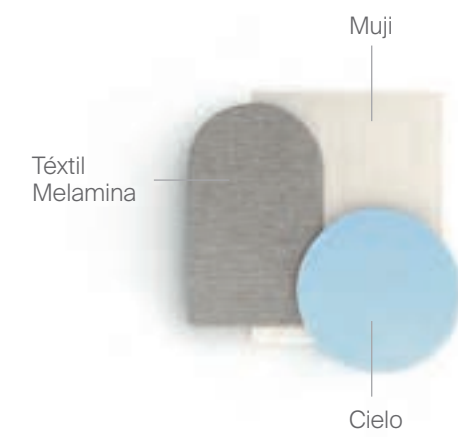



20

Diseño de habitación para dos con gran capacidad de almacenaje gracias a los armarios *Completo* y a los altillos. Como complemento se presenta un interesante chifonier con cajones junto a un original espejo de pared *Pur*.

Twin bedroom with lots of storage space, thanks to the height of the *Completo* wardrobes. In addition, this set contains a beautiful chest of drawers with an original wall mirror *Pur*.

Medidas / Measures

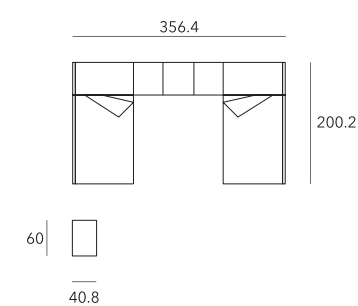

Acabados / Finishes

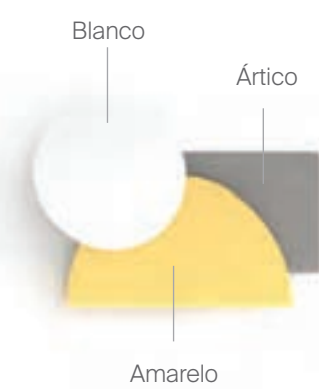



21

Habitación muy completa con un armario que incorpora un funcional escritorio extraíble, ideal solo para aquellos momentos en que sea necesario. El *Lateral Mesita-Arcón Complet* resulta un complemento muy práctico al nido *Complet* arrastre.

A complete bedroom set with wardrobe that incorporates a sliding desk, easily accessible when needed. The *Complet* side chest is a practical addition to the *Complet* pull out bed.

Medidas / Measures

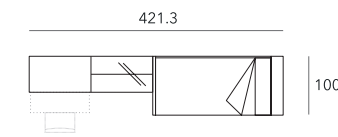

Acabados / Finishes

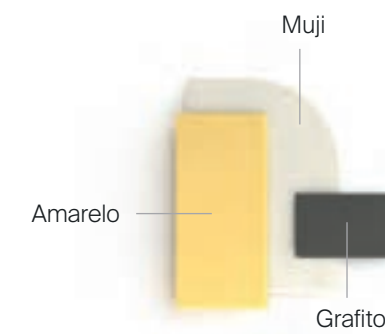

Galerías verticales Right
pensadas para almacenar
aquellos elementos que
queramos tener a la vista.

DETALLE COMPOSICIÓN N°21



22

Nido *Compleat* arrastre con lateral *Mesita-Arcón Compleat* y lateral de 5 cm de grosor junto a librerías *Troya*. El uñero de madera ayuda a crear un conjunto atractivo y original.

Nido *Compleat* pull out bed with *Compleat* side chest and *Troya* bookshelves. The wooden edge handle helps create an original and charming set.

Medidas / Measures

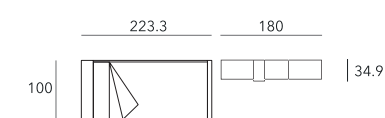

Acabados / Finishes

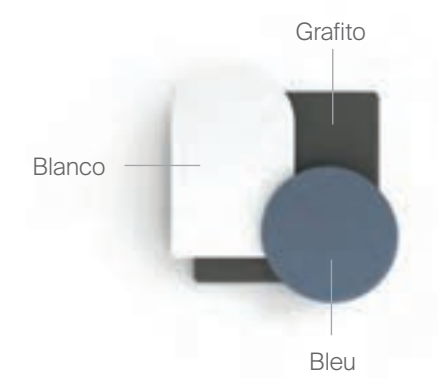





23

Habitación juvenil práctica en la que se incluye el nido *Sienna* junto a un amplio escritorio con forma. Para disponer de gran capacidad de almacenaje se ha optado por un armario de cuatro puertas plegables.

Practical kids' bedroom that includes the *Sienna* pull out bed along with a spacious shaped desk. A large wardrobe with folding doors gives even more storage space to the room.

Medidas / Measures

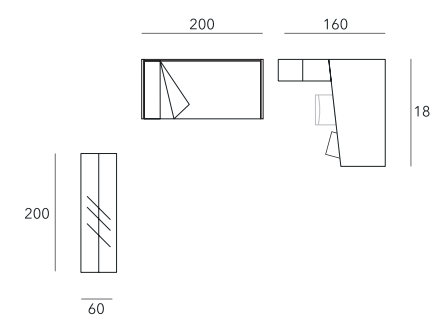

Acabados / Finishes

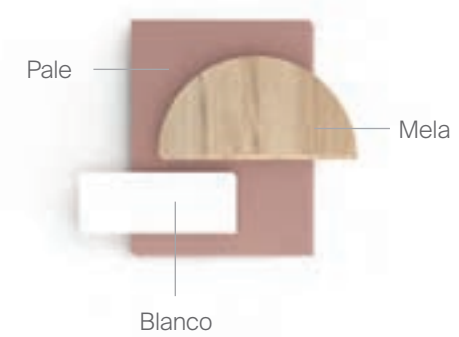

Armario de puertas plegables
que permite acceder a todo su
interior al mismo tiempo.

DETALLE COMPOSICIÓN N°23





24

Atractivo nido con laterales de 5 cm de grosor y uñeros de madera. La zona de estudio va junto a un armario en el que se ha optado por la original puerta *Natural*.

Attractive bed with wooden edge handles combines with a study area and *Natural* door wardrobe to create an original set.

Medidas / Measures

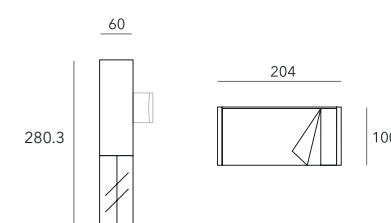

Acabados / Finishes

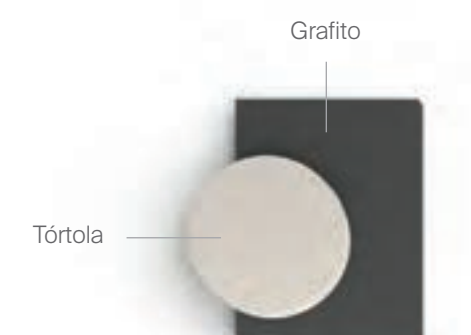





25

Dormitorio juvenil con compacto *Duo*, con dos camas de la misma medida, y armarios *Completo* que se unifican y se completan con sobrecostados consiguiendo un único elemento de almacenaje.

Compact *Duo* kids' bedroom with two same-size beds combined with *Completo* wardrobes with open shelving and drawer providing a unique storage solution.

Medidas / Measures

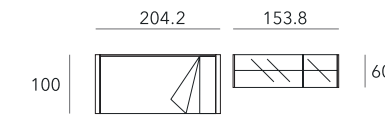

Acabados / Finishes

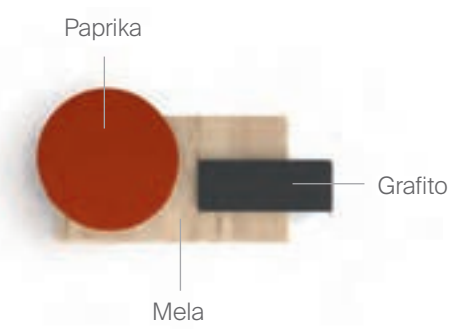

26

Solución para un espacio reducido. El amplio chifonier es perfecto para guardar pequeñas cosas.

A practical solution for small spaces. This spacious chest of drawers is perfect for storing little things.

Medidas / Measures

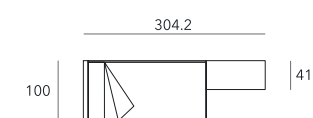

Acabados / Finishes

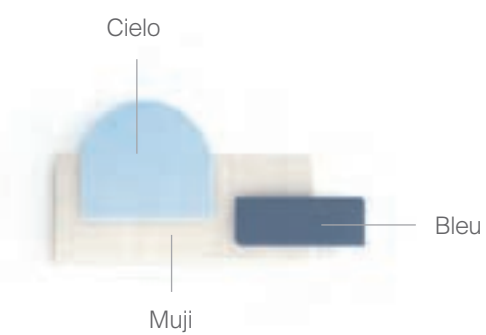



27

Composición de dormitorio juvenil con armario rinconero para aprovechar al máximo el espacio. Dos módulos *Complet* de distinta profundidad se convierten en una práctica escalera para acceder a la cama.

Kids' bedroom with a corner wardrobe to make the most of the available space. Two *Complet* units of different depths double up as practical steps to access the bed.

Medidas / Measures

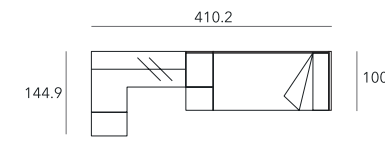

Acabados / Finishes

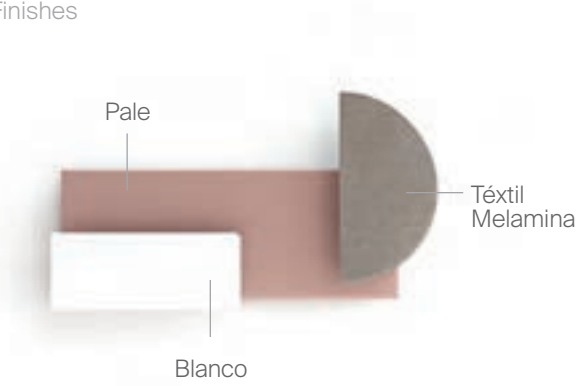

Compacto Duo con
guardamiedos Signo, permite ser
desmontado para hacer la cama
con facilidad.

DETALLE COMPOSICIÓN N°27





28

Habitación juvenil con compacto *Duo* y escritorio. La combinación de elementos *Complet* forman un amplio armario con espacios abiertos a la vista para su mayor acceso y comodidad.

Kids' bedroom with *Duo* bed & desk. This combination of *Complet* elements creates a spacious wardrobe with visible, open shelves for better access and convenience.

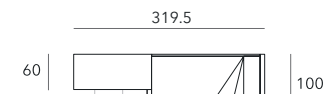

Medidas / Measures

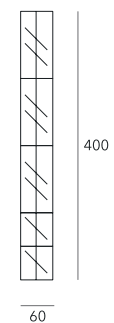

Acabados / Finishes

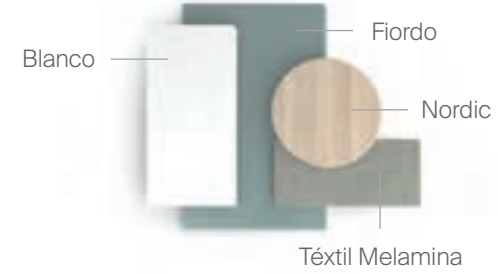



29

Dormitorio juvenil muy completo con compacto combinable y armario de rincón. La *Estantería-Escalera* para compactos resulta ideal para los más pequeños, a la vez que el escritorio abatible es perfecto para disponer de más espacio en la habitación mientras éste no se está utilizando.

Kids' bedroom with beautiful bed and corner wardrobe. The bookcase steps are ideal for little ones, while the folding desk is perfect for having more space in the room when not in use.

Medidas / Measures

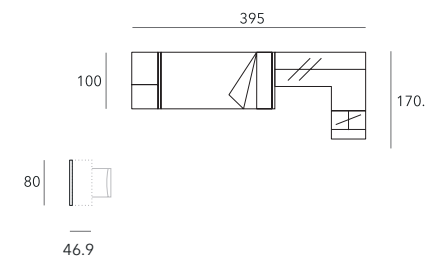

Acabados / Finishes

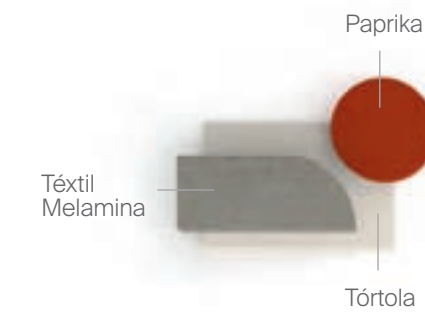



30

Propuesta de habitación juvenil pensada para albergar zona de descanso, zona de estudio y zona de almacenaje. La estantería frontal para cama resulta un buen complemento, mientras que la estantería a suelo *Mic* baja adopta una doble función, siendo soporte del escritorio al mismo tiempo que es una práctica estantería.

This Kids' bedroom features dedicated spaces for rest, study and storage. The bed's open shelving is a great storage solution and the *Mic* open shelving provides even more storage by doubling up as a bookcase.

Medidas / Measures

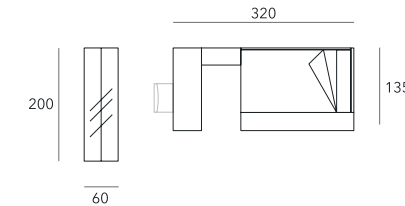

Acabados / Finishes

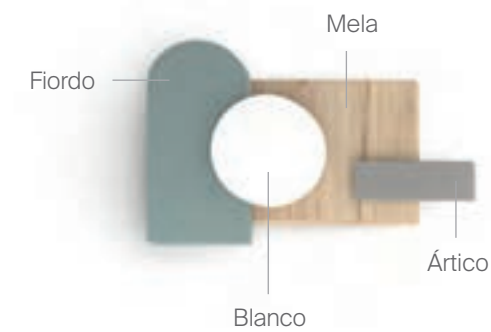

31

Diseño para pequeños espacios. La estantería frontal para cama permite tener a mano las cosas del día a día.

Designed for small rooms. The bed's open shelving offers handy access to everyday items.

Medidas / Measures

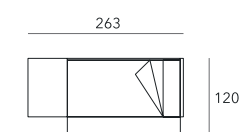

Acabados / Finishes

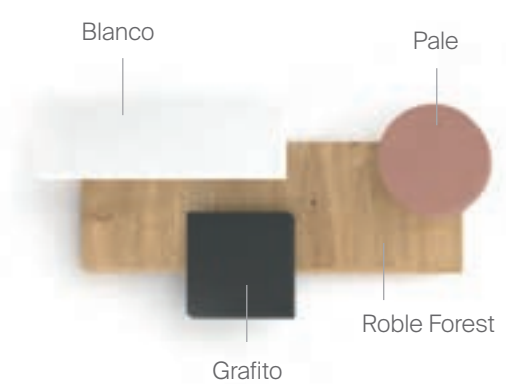

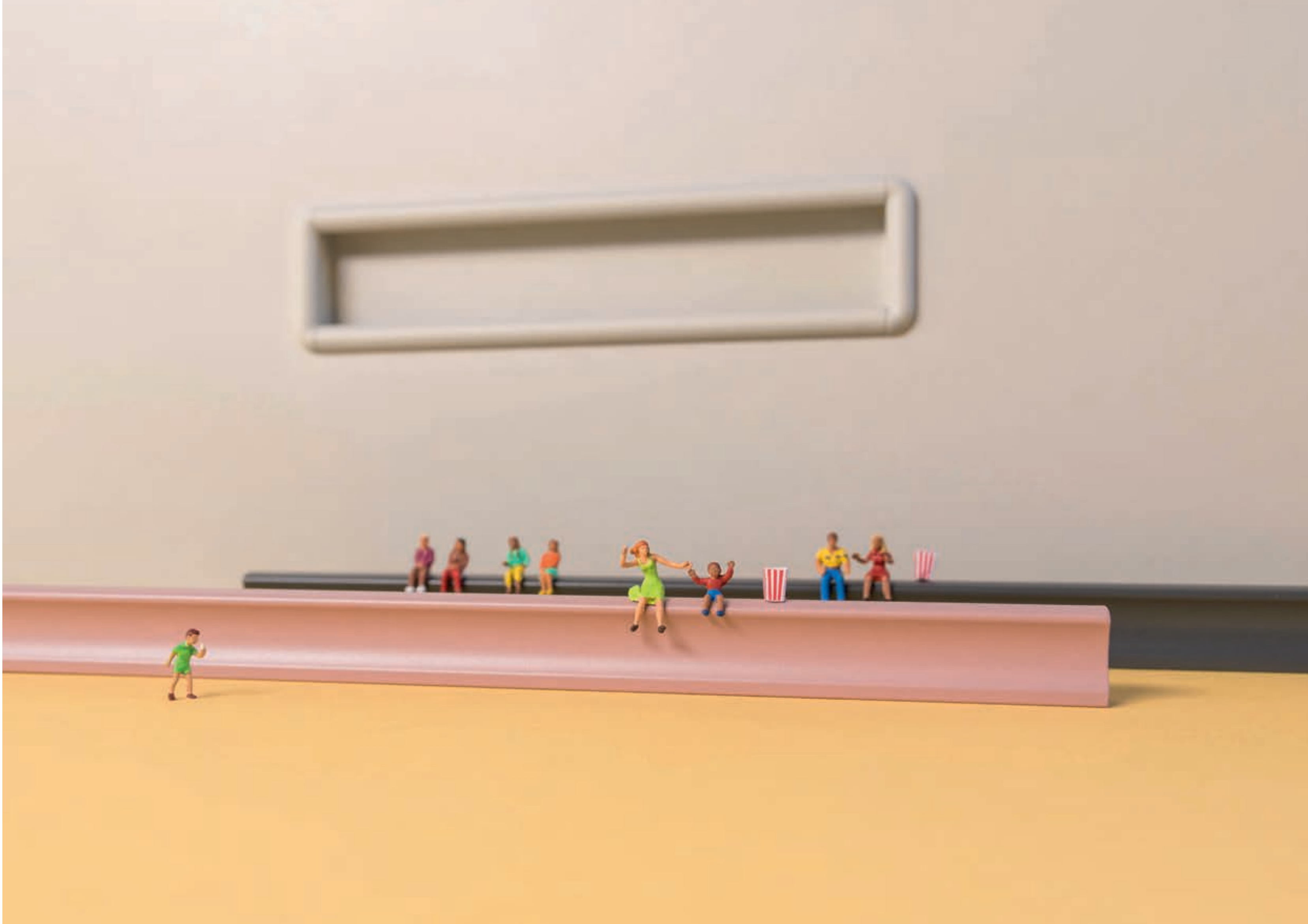

Espacio de fantasía para los más pequeños que se adapta a su crecimiento gracias a la cama convertible infantil con escritorio y juguetero. Los armarios *Árbol Mágico* y la *Estanteria Casita* permiten que todo quede ordenado de la mejor manera posible.

This fantasy kids' bedroom grows with your little ones, thanks to the kids convertible bed with fun desk. *The Árbol Mágico (Magic Tree)* and *Casita Bookcase* allow everything to be kept nice and tidy.

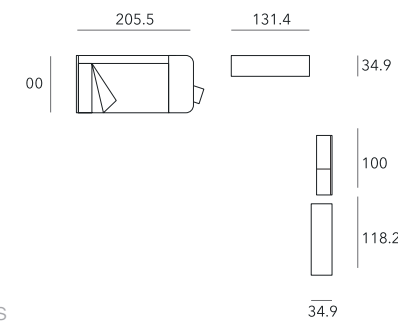

Medidas / Measures

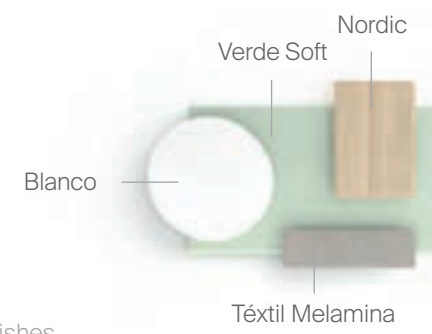

Acabados / Finishes

Convertible infantil transformado en cama juvenil para colchón de 90 x 190 cm

DETALLE COMPOSICIÓN N°32

Medidas / Measures

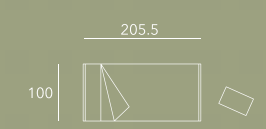

Acabados / Finishes

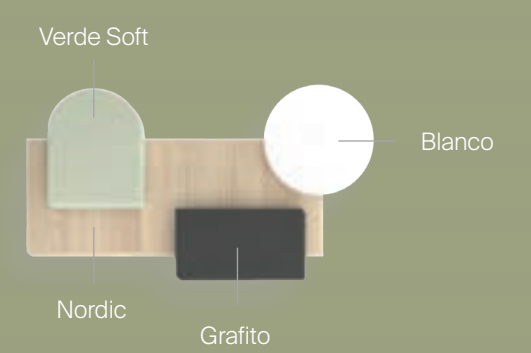

Composición *Block* con lateral *Casita* y cama inferior con tarima. La escalera *Block* lateral con cajones resulta muy práctica, mientras que el guardamiedos *Nube* ayuda a crear un conjunto con una gran personalidad.

Block bunk bed with *Casita* side and lower bed with platform. The practical *Block* ladder with drawers and the *Nube* (cloud) safety railing gives this set lots of personality.

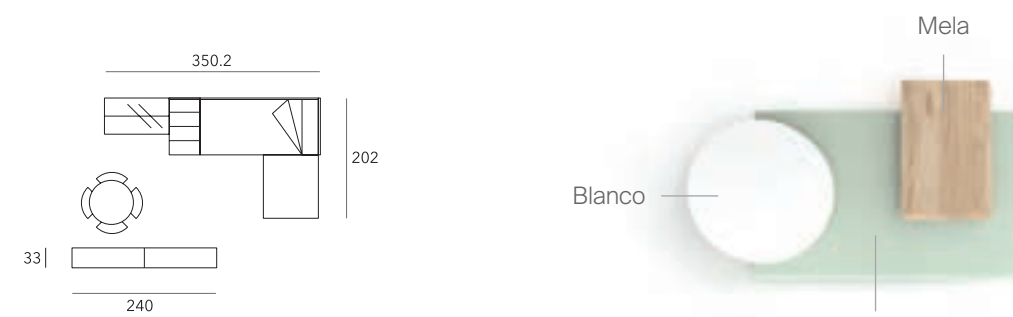

Medidas / Measures

Acabados / Finishes

34

Diseño *Block* muy completo, pensado para espacios de pocas dimensiones en el que destaca la *Escalera-Estantera con cajón*.

Block bunk bed designed for small spaces, featuring a drawer and shelves that double up as steps.

Medidas / Measures

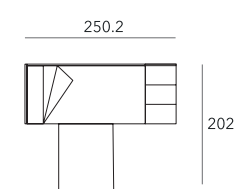

Acabados / Finishes

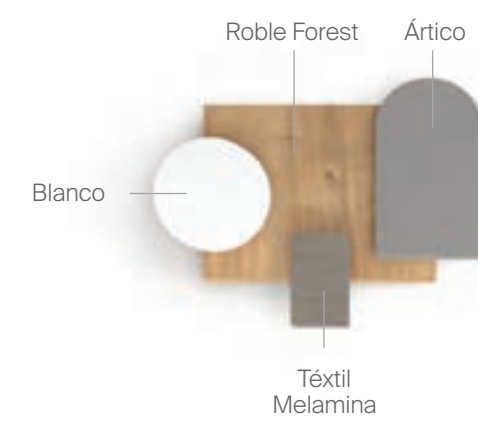



35

Propuesta actual de montaje de camas *Block* en la que destaca el sistema abatible superior, que permite un fácil acceso para poder hacer la cama con facilidad. El *Zapatero* colgado con puerta corredera resulta un complemento perfecto dado la multifuncionalidad que presenta.

Contemporary set of *Block* beds in which the top bed's folding system allows easy access for effortless bed making. A hanging shoe-rack with sliding door gives a multi-functional touch.

Medidas / Measures

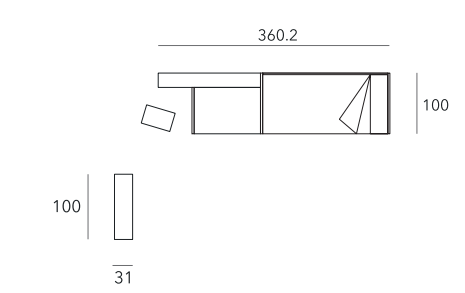

Acabados / Finishes

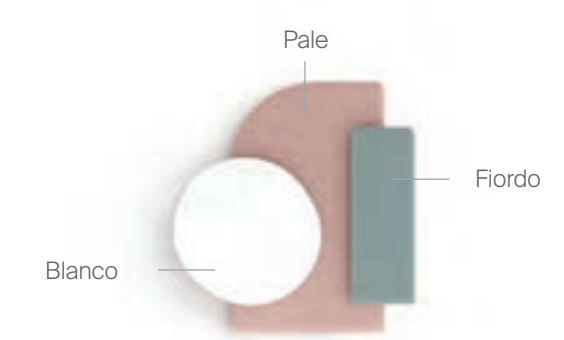

Somier abatible para cama superior, ideal para un fácil acceso a la hora de hacer la cama.

DETALLE COMPOSICIÓN N°35



Composición *Litera Loft* que permite un gran aprovechamiento del espacio en unos pocos metros, incluyendo módulos de almacenaje y zona de estudio bajo la cama.

Loft Bunk bed set with storage units and study area under the bed, making the most of tight spaces.

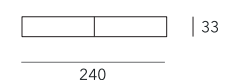
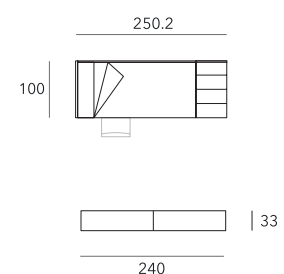

Medidas / Measures

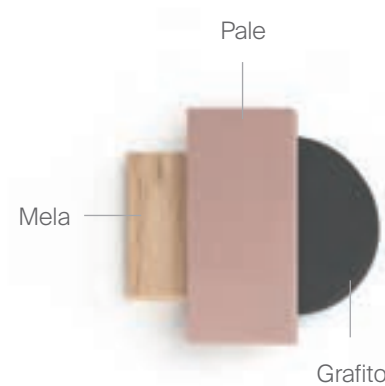

Acabados / Finishes

37

Propuesta completa para un mínimo espacio. Debajo de la cama se ubican módulos de almacenaje y zona de estudio. La escalera resulta muy útil gracias a sus cajones.

A complete solution for small rooms with storage units and a study area located under the bed. The drawers that double up as steps make good use of limited space.

Medidas / Measures

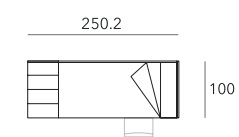

Acabados / Finishes



Ambiente amplio distribuido en varias zonas. Por una parte, en la zona de descanso se integra una singular litera *Neo* con un armario de gran altura. Por otra, la amplia librería *Add*, que combina zonas abiertas con zonas cerradas, se presenta junto a una mesa de trabajo y un *Zapatero* colgado con puerta corredera.

Spacious room layout with two distinct areas. One, a unique *Neo* bunk bed with a tall wardrobe. The other, a large *Add* bookcase combining cabinets with open shelves, a desk and a hanging shoe-rack with sliding door.





Litera Neo con somier inferior elevable, ideal para disponer de dos camas y zona de almacenaje en poco espacio

DETALLE COMPOSICIÓN N°38

Medidas / Measures

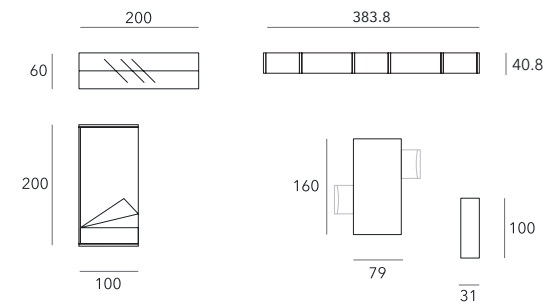

Acabados / Finishes

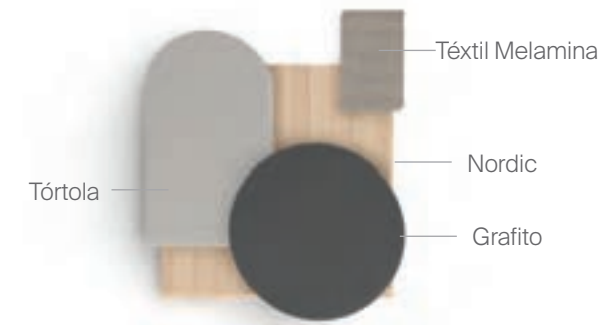



39

Dormitorio juvenil que combina una original litera *Neo* con una zona de estudio anexa a un amplio y elegante armario. Como complemento se ha optado por una cómoda *Bandeja* con zapatero incluido.

This kids' bedroom combines an original *Neo* bunk bed with study area attached to a spacious and elegant wardrobe. A chest of drawers with a shoe-rack completes the composition.

Medidas / Measures

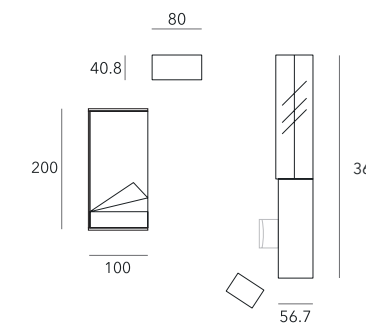

Acabados / Finishes

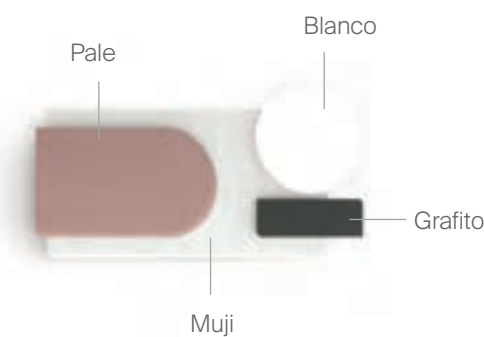



Cómoda bandeja con cajones y zapatero, perfecto para disfrutar de una habitación totalmente ordenada.

DETALLE COMPOSICIÓN N°39



Dormitorio infantil con litera *Casita* y un pequeño armario *Completo*. La mesa infantil *Toy* junto a los taburetes a juego crean una zona donde los pequeños tienen libertad para dibujar, leer o hacer sus deberes.

Kids' bedroom with *Casita* bunk bed and small *Completo* wardrobe. The *Toy* kids' table, along with matching stools, provides an area where children can enjoy drawing, reading and doing their homework.

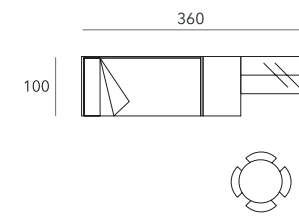

Medidas / Measures

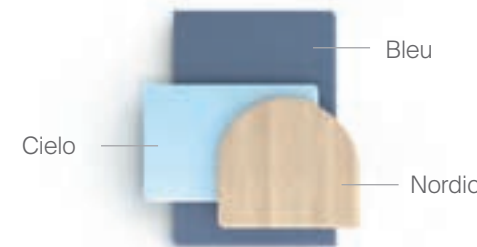

Acabados / Finishes

41

Propuesta infantil con litera *Casita* asimétrica. El armario *Árbol Mágico* resulta un complemento perfecto para crear un ambiente único.

Kids' bedroom with asymmetrical *Casita* bunk bed. The *Árbol Mágico (Magic Tree)* bookcase is the perfect element to create a unique space.

Medidas / Measures



Acabados / Finishes

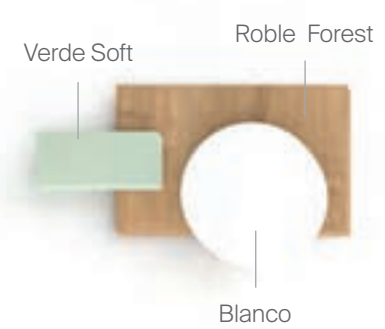



42

Solución para espacios reducidos en los que se precisa orden y capacidad de almacenaje, así como una pequeña zona de trabajo.

Perfect solution for small rooms giving lots of storage space as well as a small study area.

Medidas / Measures

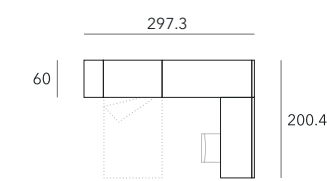

Acabados / Finishes



43

Ambiente en el que se combina una cama abatible vertical *Murphy* y un armario con escritorio extraíble. Ideal para estudio o apartamento de pequeñas dimensiones.

Practical composition that combines a vertical *Murphy* bed and a wardrobe with a removable/sliding desk. Perfect for studios or small apartments.

Medidas / Measures

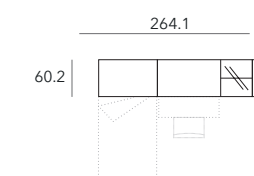

Acabados / Finishes





44

Dormitorio con una gran estantería *Troya*, en la que se incluye un práctico escritorio, y una cama *Murphy* abatible horizontal. Elementos perfectos para tener un espacio siempre en orden.

Bedroom with large *Troya* bookshelf, practical desk and a horizontal *Murphy* bed is the perfect combination for tidy spaces.

Medidas / Measures

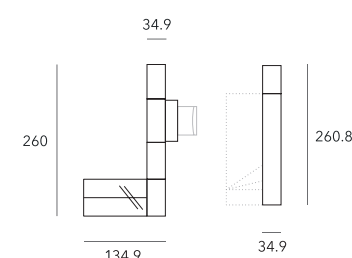

Acabados / Finishes

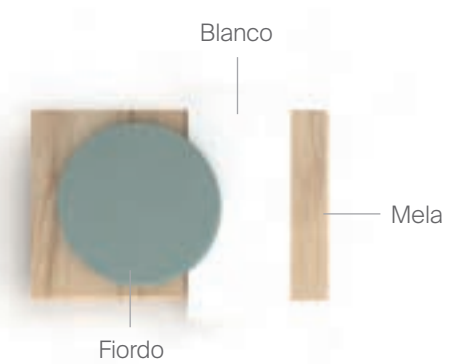

Cama horizontal con estantería complementaria, ideal para uso diario o para las visitas inesperadas.

DETALLE COMPOSICIÓN N°44



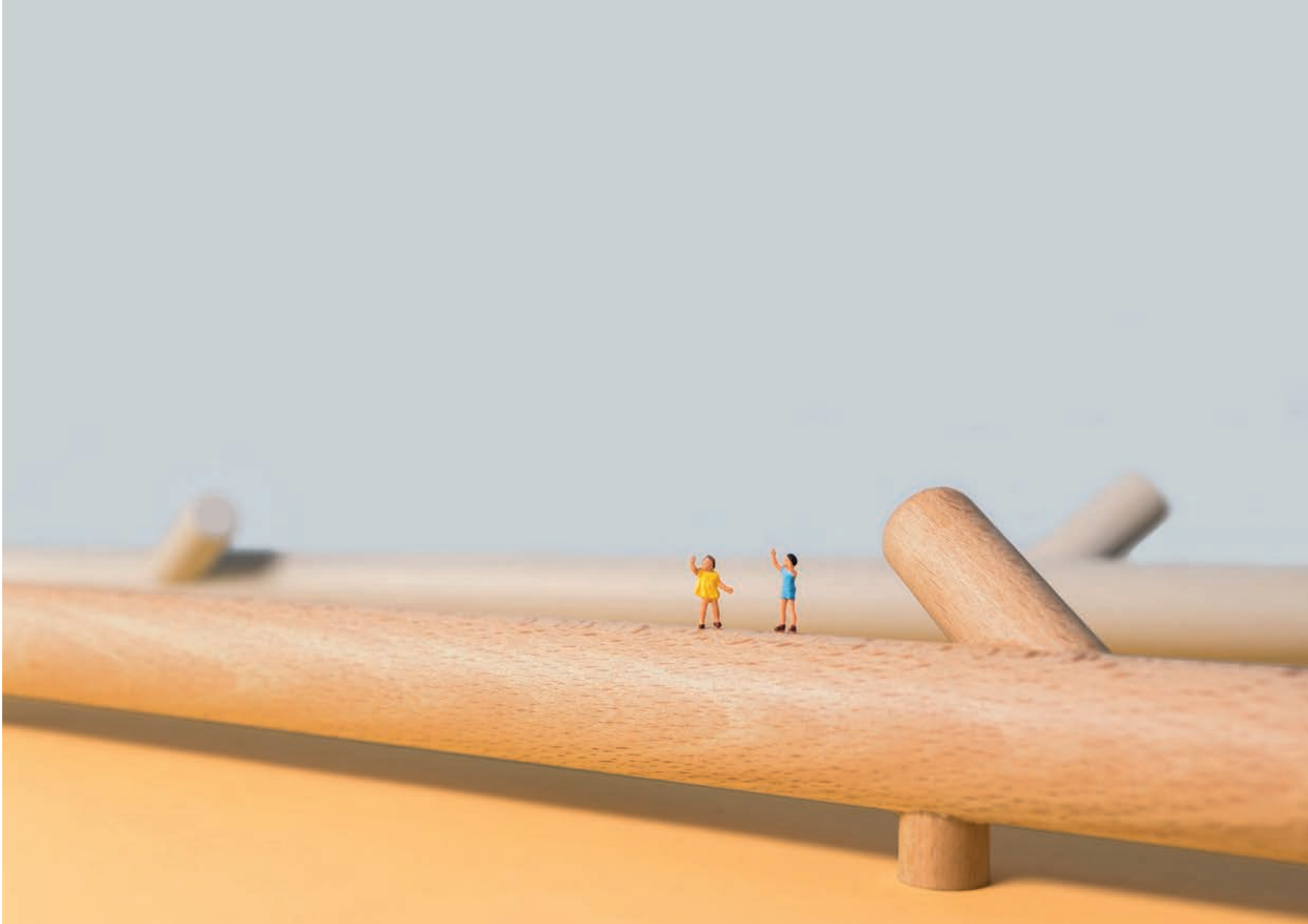



45

Espacio donde se presenta un completo armario de rincón para aprovechar al máximo y poder guardar infinidad de ropa y otros objetos. Junto al armario se ha instalado una cama *Murphy* abatible superior con una cama a nivel del suelo.

Bedroom with corner wardrobe, perfect for storing countless clothes and other objects. An upper *Murphy* bed and lower bed beside the wardrobe completes this set.

Medidas / Measures

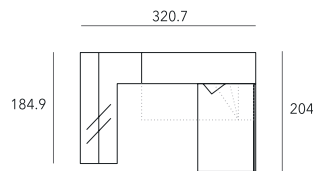

Acabados / Finishes

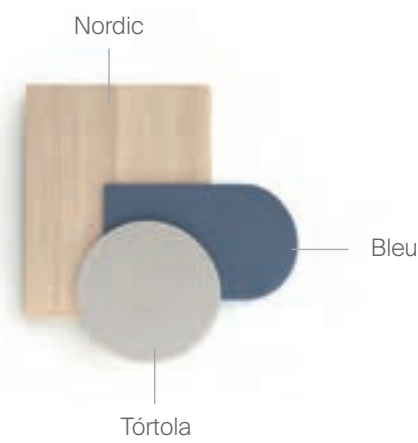

Armario de rincón junto a un armario terminal zapatero, combinación práctica y de gran capacidad.

DETALLE COMPOSICIÓN N°45





46

Propuesta de dos camas abatibles *Murphy* pensada para aquellos espacios en los que se quiere aprovechar el espacio al máximo. La cama superior incorpora un sistema exclusivo de fácil acceso y doble accionado de seguridad.

This *Murphy* bunk bed set provides a clever solution to make the most of small spaces. The top bed has an exclusive, easy access system as well as a double safety button.

Medidas / Measures

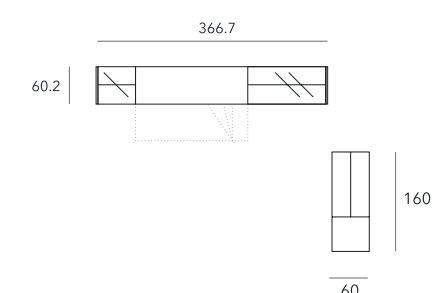

Acabados / Finishes



Composición de módulos
pensada como zona de
entretenimiento.

DETALLE COMPOSICIÓN N°46





47

Espacio exclusivo con un conjunto de cama abatible con altillo y armario de puertas plegables. Aparte, se presenta una zona de estudio presidida por una amplia y práctica estantería *Add* con huecos, puertas y cajones.

Distinctive space with folding bed and upper storage cabinet next to a wardrobe with folding doors. In addition, there is a study area with large and practical *Add* bookcase with open shelves, doors and drawers.

Medidas / Measures

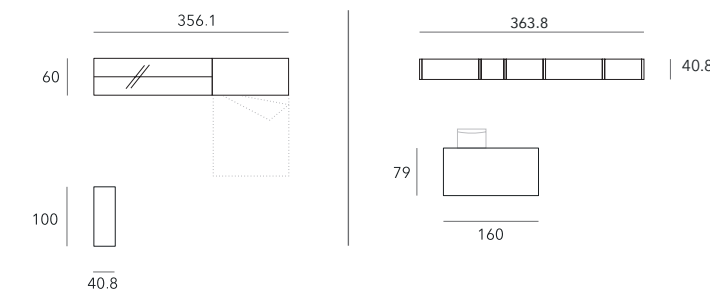

Acabados / Finishes

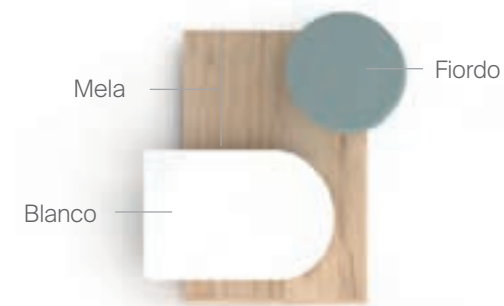

Librería Add con combinación
de huecos, puertas y cajones.
Ideal para cualquier rincón de
la casa.

DETALLE COMPOSICIÓN N°47







48

Espacio juvenil en el que se presentan dos camas individuales *Cotton* con cabecero tapizado desenfundable, que consiguen un ambiente cálido y acogedor. Una amplia zona de estudio resulta el complemento ideal.

Kids' bedroom consisting of two single *Cotton* beds with removable upholstered headboards that give a warm and cozy feel. A large study area complements this set well.

Medidas / Measures

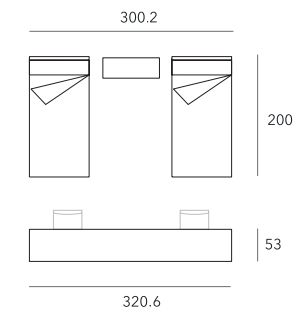

Acabados / Finishes

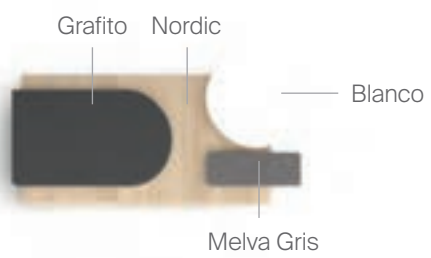

49

Propuesta con la singular cama tapizada *Cotton* en sus diferentes opciones. Esta cama, además, permite elegir entre varios acabados de tapizado.

This unique *Cotton* bed with removable covers comes in three different options allowing you to choose between upholstery finishes.

Medidas / Measures

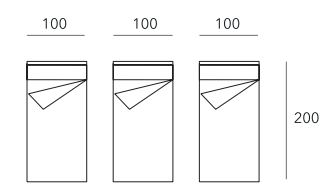

Acabados / Finishes





50

Ambiente senior con cama *Cotton* tapizada desenfundable y mesillas con el singular *uñero* de madera. El amplio armario de puertas correderas, que se presenta con iluminación interior, resulta un complemento genial.

This bedroom set contains an upholstered *Cotton* bed with removable cover plus nightstand with a wooden edge handles. The spacious wardrobe with sliding doors and hidden LED lighting gives a high-end touch.

Medidas / Measures

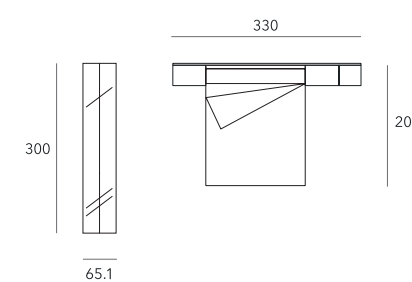

Acabados / Finishes

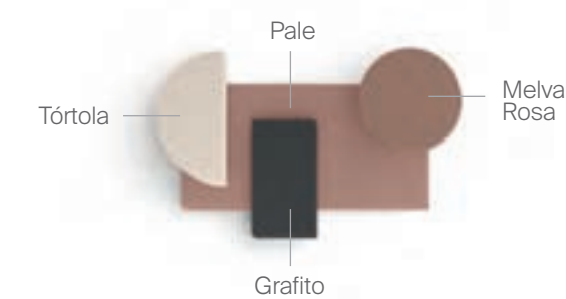



Cama Cotton totalmente
desenfundable, perfecta para
conseguir un espacio atractivo y
confortable.

DETALLE COMPOSICIÓN N°50





51

Dormitorio senior que combina el cabecero *Olimpia* con una mesilla colgada y un sobre bandeja. Para disponer de un mueble de gran capacidad se ha optado por una cómoda con múltiples cajones.

Stylish bedroom featuring the *Olimpia* headboard, a floating nightstand on one side and double side table with tray top on the other. Combined with a double chest of drawers for plenty of storage.

Medidas / Measures

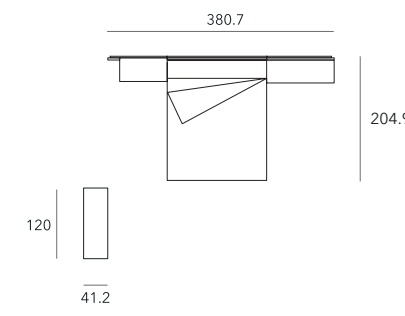

Acabados / Finishes

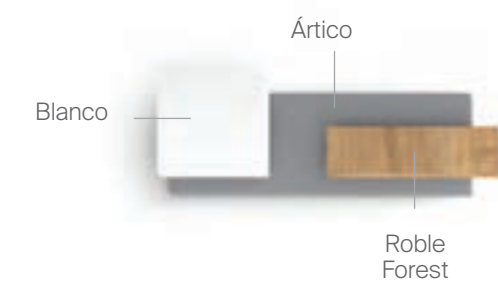

52

Propuesta individual que integra zona de descanso y zona de estudio. La mesilla colgada aporta un aire muy actual al conjunto, así como el soporte del escritorio.

Contemporary single bedroom integrating both rest and study. The floating nightstand combined with minimalist desk gives a modern feel.

Medidas / Measures

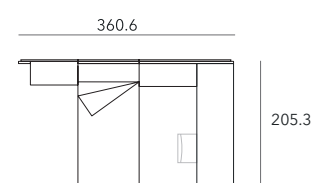

Acabados / Finishes

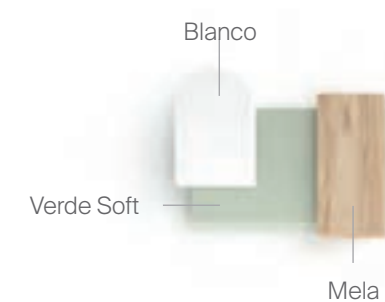

53

Espacio senior con un elegante cabecero rematado por un ala con luz LED. En el otro extremo se plantea una mesa con un espejo, dejando al aire sus varias funcionalidades. El armario resulta un perfecto complemento.

Double bedroom with elegant headboard and hidden LED lighting. At the other end a multi-purpose table and mirror combines with a wardrobe for the perfect finish.

Medidas / Measures

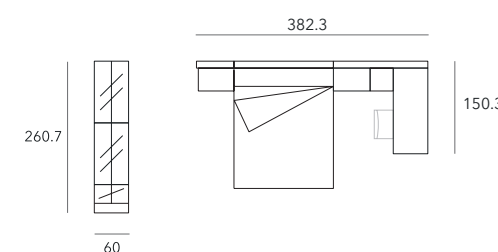

Acabados / Finishes

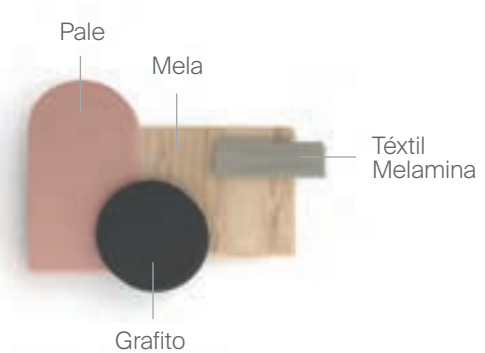



Armario Open colgadores que permite albergar elementos que queremos tener ocultos y otros que no nos importa tener a la vista.

DETALLE COMPOSICIÓN N°53





54

Amplia habitación con multitud de cajones y una cama que incorpora un práctico cajón zapatero. El armario, que destaca por tener un cuerpo con un lateral fijo, es ideal para espacios en los que no se dispone de espacio suficiente para abrir las puertas.

Spacious bedroom with several drawers on either side of the bed and a hidden shoe organizer. The wardrobe has a fixed side ideal for small spaces where opening the doors may be an issue.

Medidas / Measures

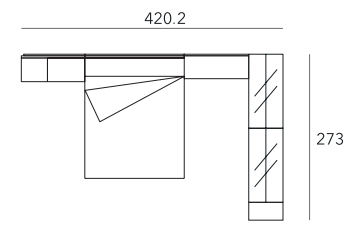

Acabados / Finishes



Composición con armario ciego,
pensado para los espacios más
ajustados.

DETALLE COMPOSICIÓN N°54



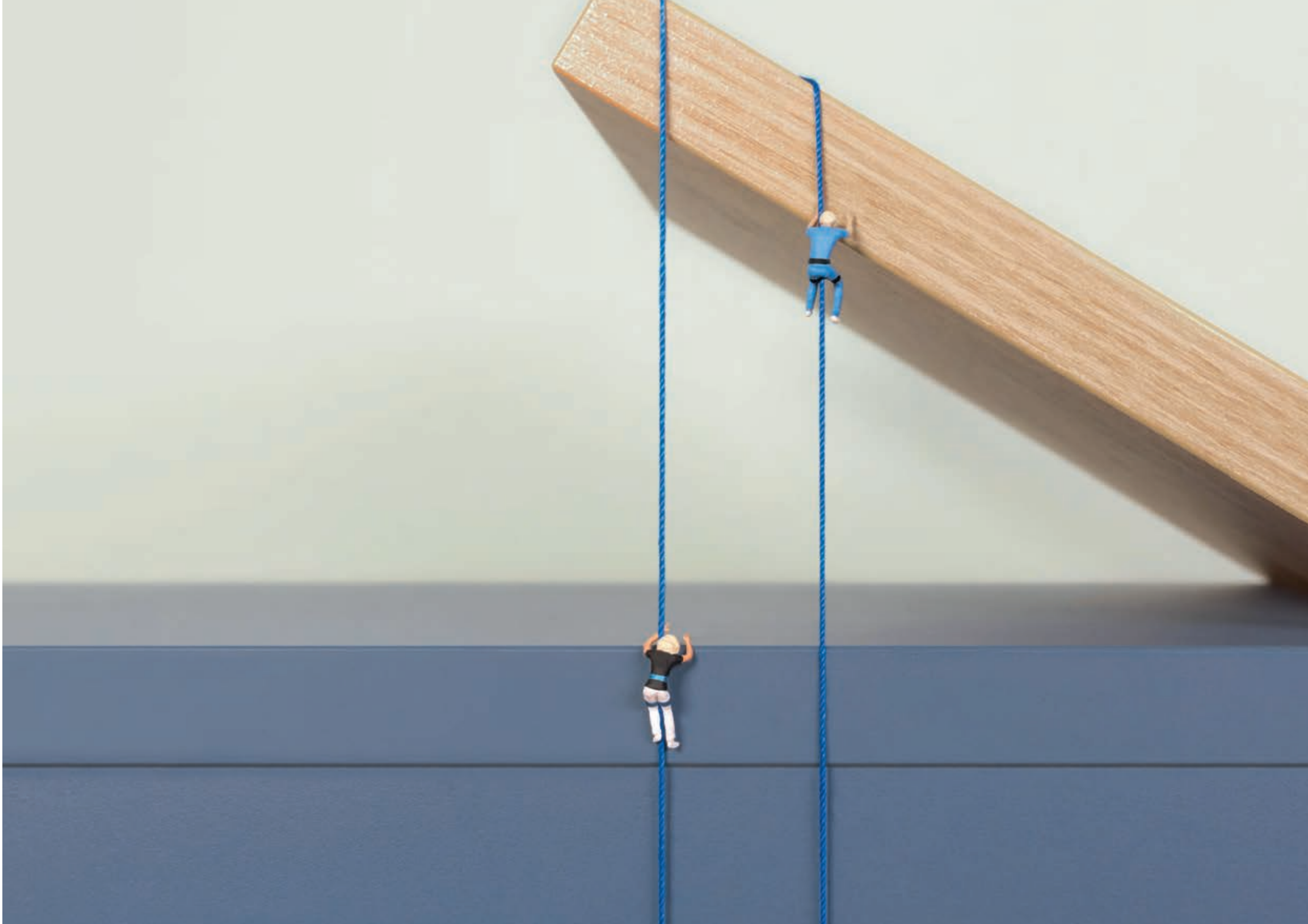

55

Armario elegante que combina puertas con elementos huecos y terminal zapatero. Ideal para tener todo en orden.

Elegant wardrobe combining doors and open shelving with shoe storage. Perfect for keeping everything neat and tidy.

Medidas / Measures

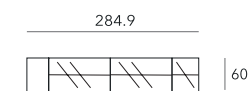

Acabados / Finishes

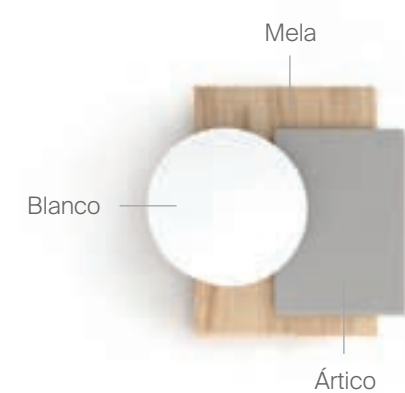

56

Propuesta de armario, con el uñero de metal, que incluye elementos *Completo* como el cubo *Completo* con partidor.

Modern wardrobe with aluminum edge handles and other *Completo* elements.

Medidas / Measures

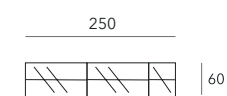

Acabados / Finishes

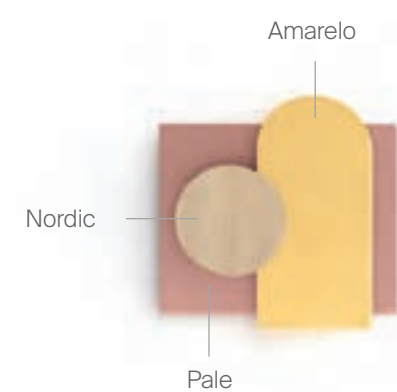



57

Armario singular gracias a las puertas *Natural*, que combinan dos plafones con uñero de madera. El armario se remata con sobrecostados para un perfecto acabado.

Unique wardrobe with *Natural* doors that combines two panels with wooden edge handles. The wardrobe is finished with paneling to offer a high-end finish.

Medidas / Measures

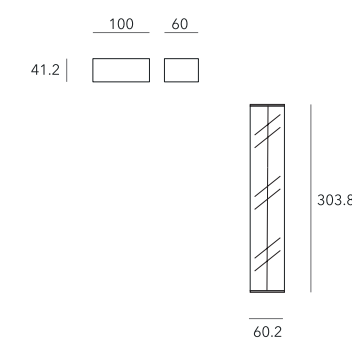

Acabados / Finishes

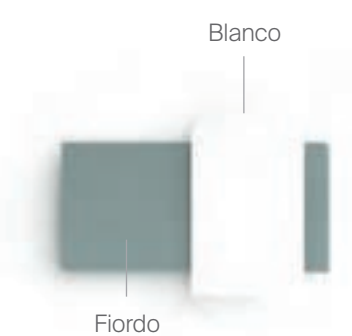

58

Propuesta atractiva de armario con puertas batientes que combina puertas lisas y puertas *Natural*. Ideal tanto para un ambiente juvenil como para un ambiente más senior.

Beautiful wardrobe combing both smooth and *Natural* hinged doors, perfect for both kids and adults.

Medidas / Measures

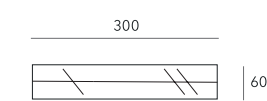

Acabados / Finishes

Tórtola





59

Vestidor personalizado que combina varios acabados y diversos complementos interiores. La iluminación LED resulta un complemento perfecto para hacerlo único.

Custom dresser combining several finishes and accessories. The LED lighting gives a unique touch.

Medidas / Measures

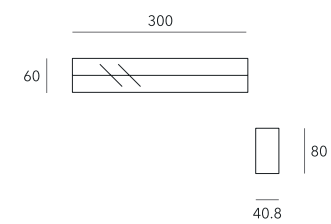

Acabados / Finishes

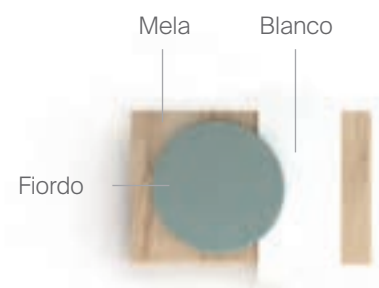

Chifonier bandeja de gran funcionalidad gracias a los cajones y el zapatero que incorpora.

DETALLE COMPOSICIÓN N°59



60

Propuesta de armario con todos los modelos de puertas batientes disponibles.

Wardrobe available with all hinged door models options.

Medidas / Measures

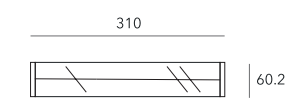

Acabados / Finishes

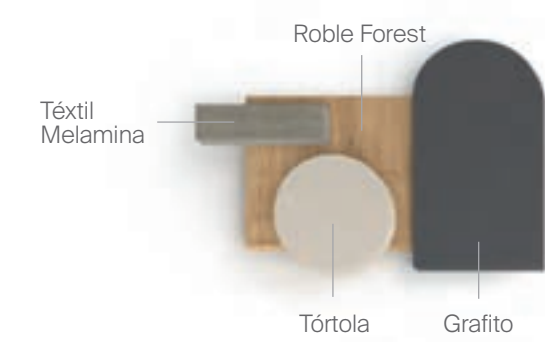

RESUMEN DE COMPOSICIONES
Summary of compositions



01. Pág. 2



02. Pág. 4



03. Pág. 8



04. Pág. 10

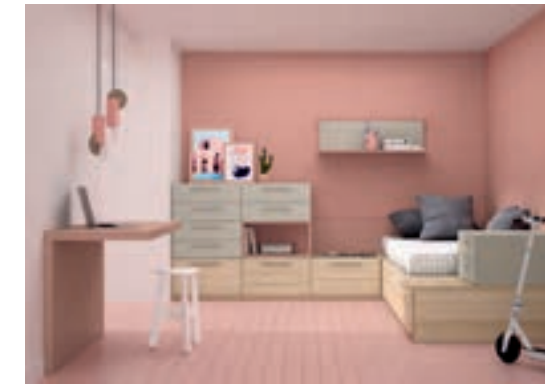

05. Pág. 12



16. Pág. 42



17. Pág. 44

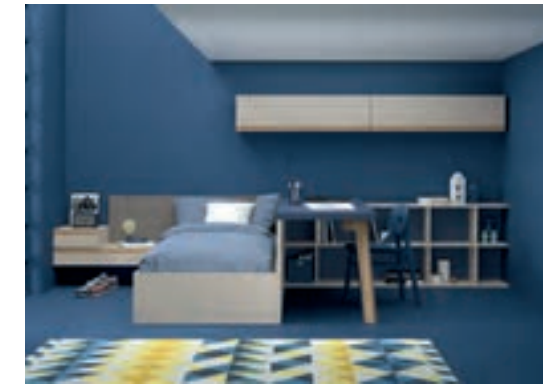

18. Pág. 46



19. Pág. 48

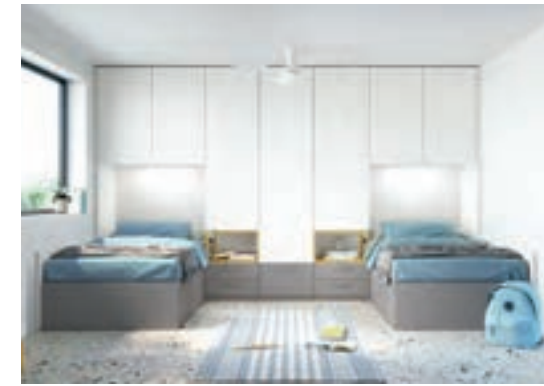

20. Pág. 50

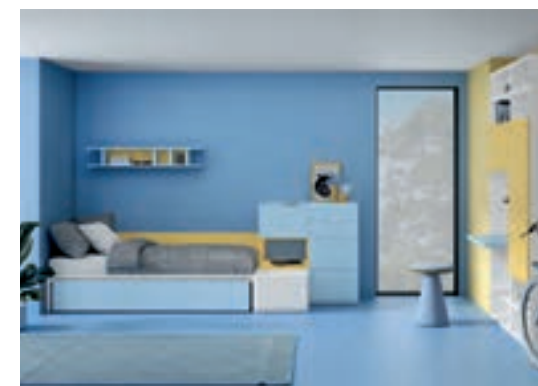

06. Pág. 16



07. Pág. 20



08. Pág. 24



09. Pág. 26



10. Pág. 28



21. Pág. 52



22. Pág. 56

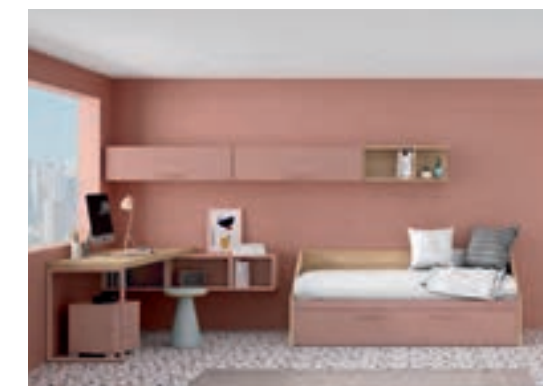

23. Pág. 60

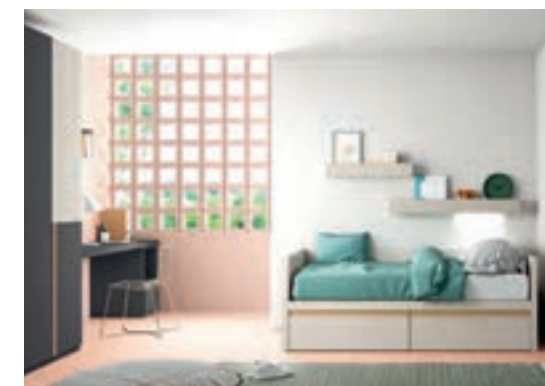

24. Pág. 64



25. Pág. 68



11. Pág. 32



12. Pág. 34



13. Pág. 36



14. Pág. 38



15. Pág. 40



26. Pág. 70



27. Pág. 72



28. Pág. 76



29. Pág. 78



30. Pág. 80

RESUMEN DE COMPOSICIONES
Summary of compositions



31. Pág. 82



32. Pág. 86



33. Pág. 90



34. Pág. 92



35. Pág. 94



46. Pág. 128



47. Pág. 132



48. Pág. 138



49. Pág. 140



50. Pág. 142



36. Pág. 98



37. Pág. 100



38. Pág. 102



39. Pág. 106



40. Pág. 110



51. Pág. 146



52. Pág. 148



53. Pág. 150



54. Pág. 154



55. Pág. 160



41. Pág. 112



42. Pág. 114



43. Pág. 118



44. Pág. 118



45. Pág. 124



56. Pág. 162

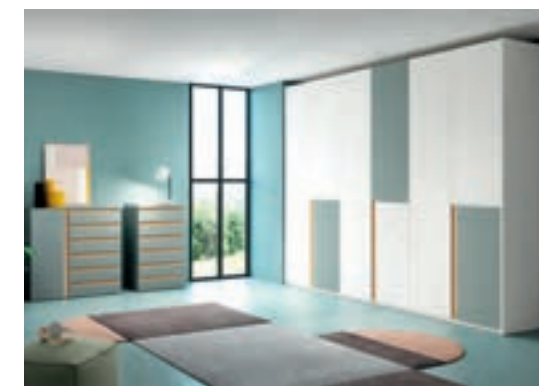

57. Pág. 164



58. Pág. 166



59. Pág. 168



60. Pág. 172

ACABADOS DISEÑO MADERA
Wood finishes

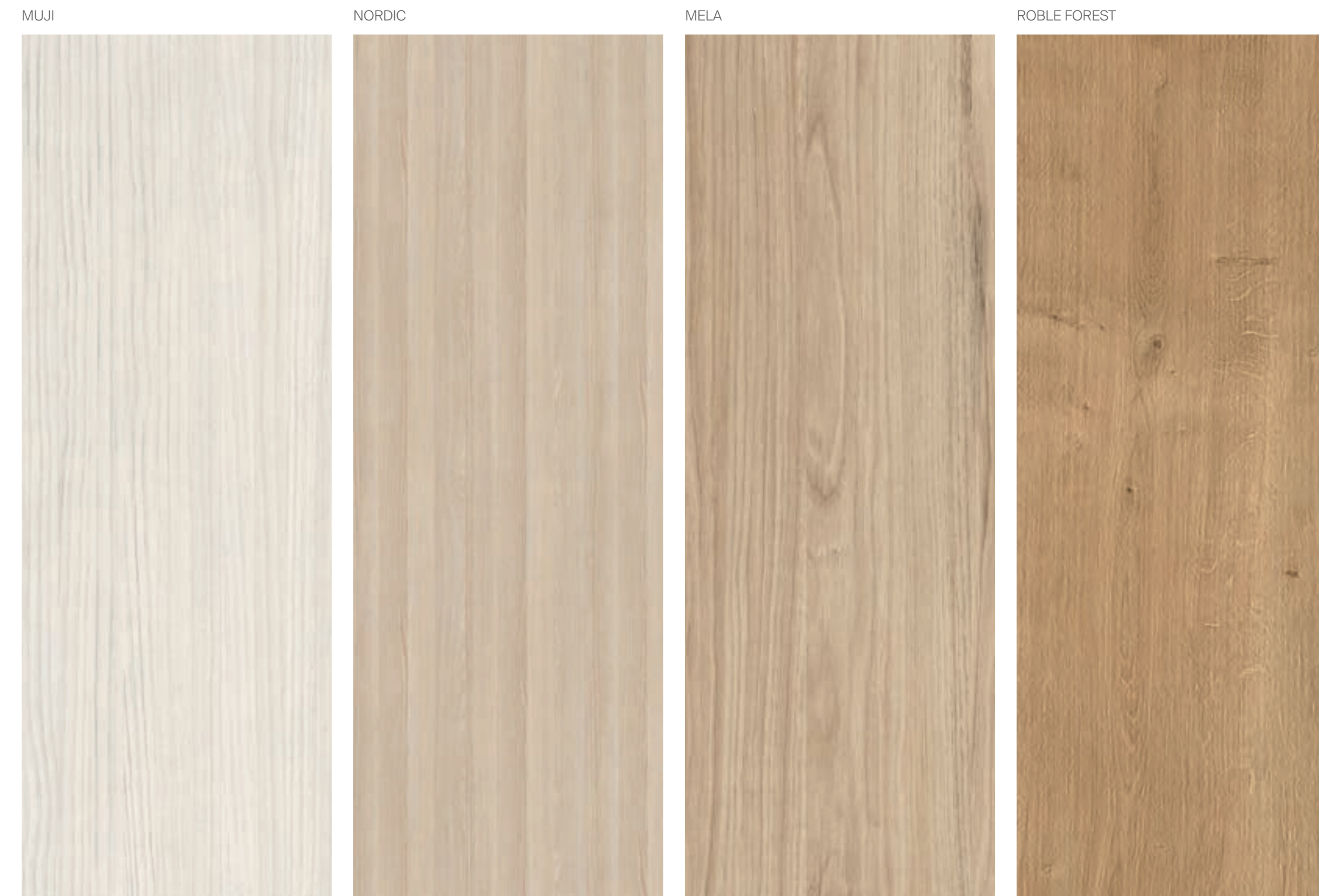

ACABADOS UNICOLORES
Unicolour finishes



ACABADOS ESPECÍFICOS
Specific finishes



ACABADOS POLIPIEL
Leatherette finishes



ACABADOS TEXTILES
Textil finishes



TIRADORES COMBINABLES
Combinable handles

TIRADOR RECTÁNGULO MADERA



TIRADOR RECTÁNGULO LACA



TIRADOR ATRIO



TIRADOR TAP



TIRADOR DIDALET MADERA



TIRADOR DIDALET LACA



TIRADOR TIPI 25



TIRADOR PICCOLO



TIRADOR BOLD



TIRADOR PESTAÑA



TIRADOR STARK



TIRADOR GRADO



TIRADORES ESPECÍFICOS
Specific handles

TIRADOR UÑERO MADERA



TIRADOR BRANCA MADERA



TIRADOR BRANCA LACA



TIRADOR TIPI 70



TIRADOR PERFIL



TIRADOR UÑERO METAL



TIRADOR CASITA



Créditos

Credits

Diseño de producto / Product Designer

Antaix Lab

Desarrollo técnico / Technical development

Oficina técnica Antaix

Technical development Antaix

Fotografía / Photography

Carlos Gutiérrez

Catorcestudio

Diseño gráfico / Graphic design

coolte.net

Textos / Texts

Mario Roperó

Antaix

Imprenta / Printers

Pentagraf impresores S.L.

ANTAIX

THE ORIGINAL
SINCE 1979

stay

ANTAIX

THE ORIGINAL
SINCE 1979